



Two tops table

I made a mistake, I fixed the table-top under the supporting bars instead of on top, and found a space which was always there but was never seen, I created a lid to cover and to hide and change a few hundred years of classic table making.

Designer	Marcel Wanders	
Year of design	2004	
Material	Solid oak frame with a veneer top	
Additional	Stained and lacquered in 7 different colours (with visible wood structure)	
Product Codes	Moooi, tables, two tops table. (180cm)	MOTTTT189**
	Moooi, tables, two tops table. (220cm)	MOTTTT229**
	Moooi, tables, two tops table. (260cm)	MOTTTT269**

Detailing











Two tops has a discreet outlet for cables.

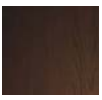

Stoppers are located at the rear to prevent the table top being too close to the wall to open.

Colour

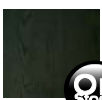
 White RAL9016 (*I)	 Black RAL9005 (*K)	 Red RAL3020 (*R)	 Orange RAL2004 (*C)	 Natural Lacquer (*N)
 Wenge (*E)	 Natural Oil (*A)	 Bloody Brown (*O)	 Grey Brown (*G)	 White Wash (*W)
 Black Stained (*B)				



Main dimensions

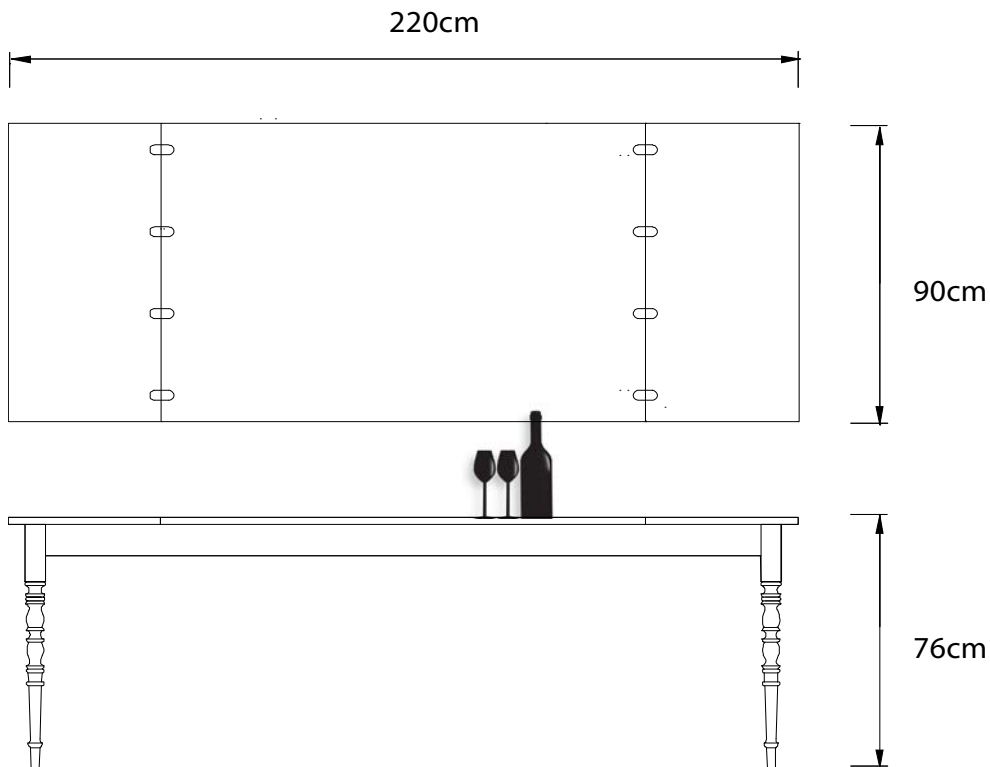
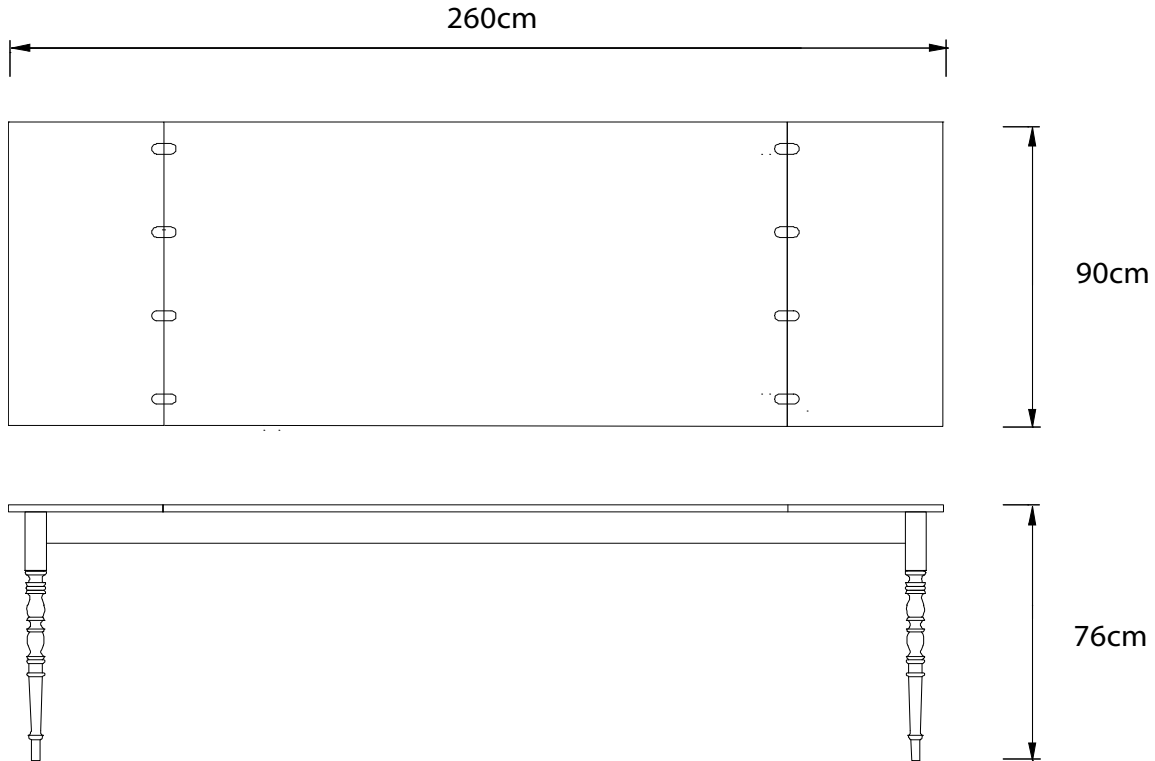

Main dimensions

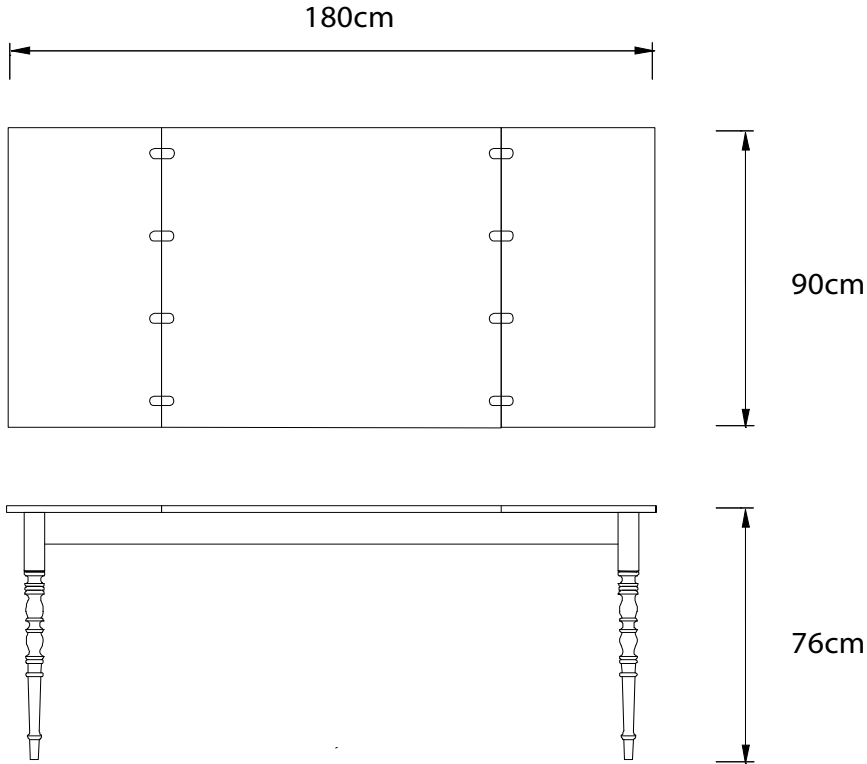

Technical

The Two tops table will require some assembly before use. The legs will need attaching which you will find inside the box with the table top. To attach the legs simple align and turn the legs in a clockwise motion until the legs no longer turn. Repeat this for all four legs. It is best to do this whilst the table top is still packaged and upside-down. The tables are heavy items and may require more than one person to manuver. If you are unsure of anything please contact our product development team for advice.

Packaging

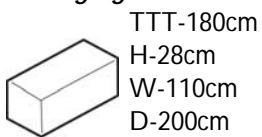

1-Colli
57-Net
60-Gross

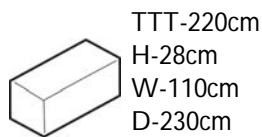

1-Colli
69-Net
74-Gross

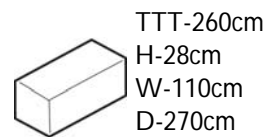

1-Colli
78-Net
84-Gross

m o o o i[®]

Photography

Photography pending ^S

Cleaning Instructions

Moool recommends using a trusted household furniture polish and a soft, non-abrasive cloth to create an even sheen. Always read the label of any cleaning products you wish to use on Moool furniture.
