



## AVL table

Celebrating the innovations derived directly from the Shaker communities, 'Atelier Van Lieshout' have created the perfect partner for the cheeks. Encompassing all the qualities of the traditional craftsmanship yet captivating a totally contemporary aesthetic.

<b>Designer</b>	Joep van Lieshout	
<b>Year of design</b>	1999	
<b>Material</b>	Solid Oak stained and lacquered in 7 different colours Or Ash veneer top, solid beech frame lacquered in 4 different RAL colours.	
<b>Additional</b>	Space between floor and table 63 cm	
<b>Product Codes</b>	Mooi, tables, AVL shaker, solid oak,-75x75x75cm	MOTAVO077SL
	Mooi, tables, AVL shaker, solid oak,-75x140x75cm	MOTAVO141SL
	Mooi, tables, AVL shaker, solid oak,-75x200x75cm	MOTAVO201*L
	Mooi, tables, AVL shaker, solid oak,-75x300x75cm	MOTAVO301*L
	Mooi, tables, AVL shaker, solid beech.-75x75x75cm	MOTAVE077CL
	Mooi, tables, AVL shaker, solid beech.-75x140x74cm	MOTAVE141CL
	Mooi, tables, AVL shaker, solid beech.-75x200x75cm	MOTAVE201CL
	Mooi, tables, AVL shaker, solid beech.-75x300x75cm	MOTAVE301CL











### Detailing



The shaker chair is designed to fit neatly underneath the AVL table.

# m o o o i<sup>®</sup>

## Colour

	White RAL9016 (*I)		Black RAL9005 (*K)		Red RAL3020 (*K)		Orange RAL2004 (*C)		Natural Lacquer (*N)
	Wenge (*E)		Black Stained (*B)		Bloody Brown (*O)		Grey Brown (*G)		White Wash (*W)
	Natural Oil (*A)								

## Main dimensions

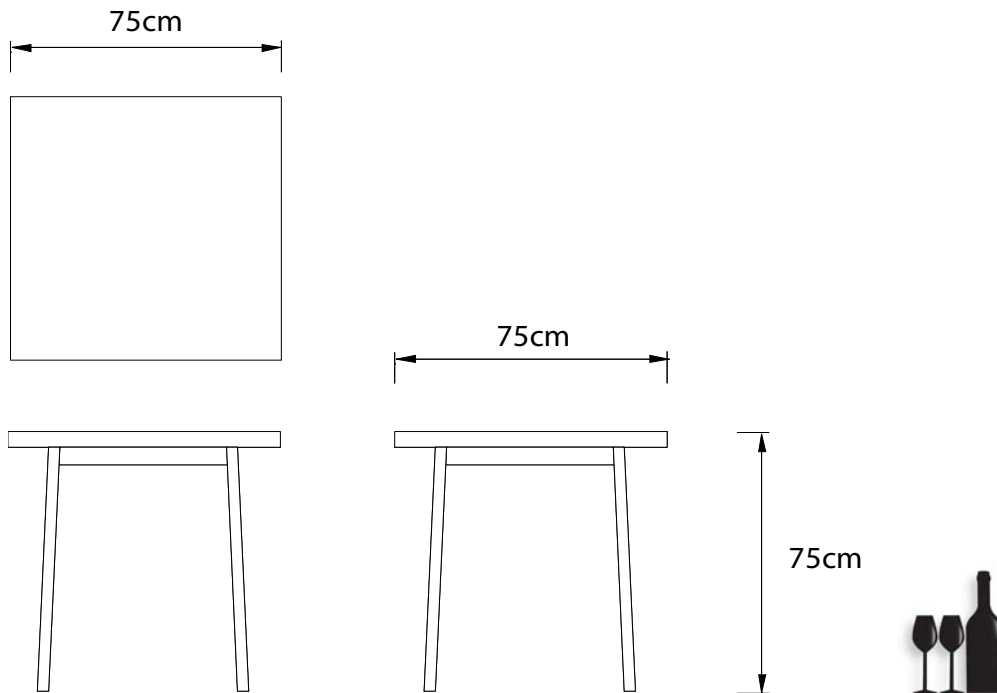

m o o o i<sup>®</sup>

*Main dimensions*

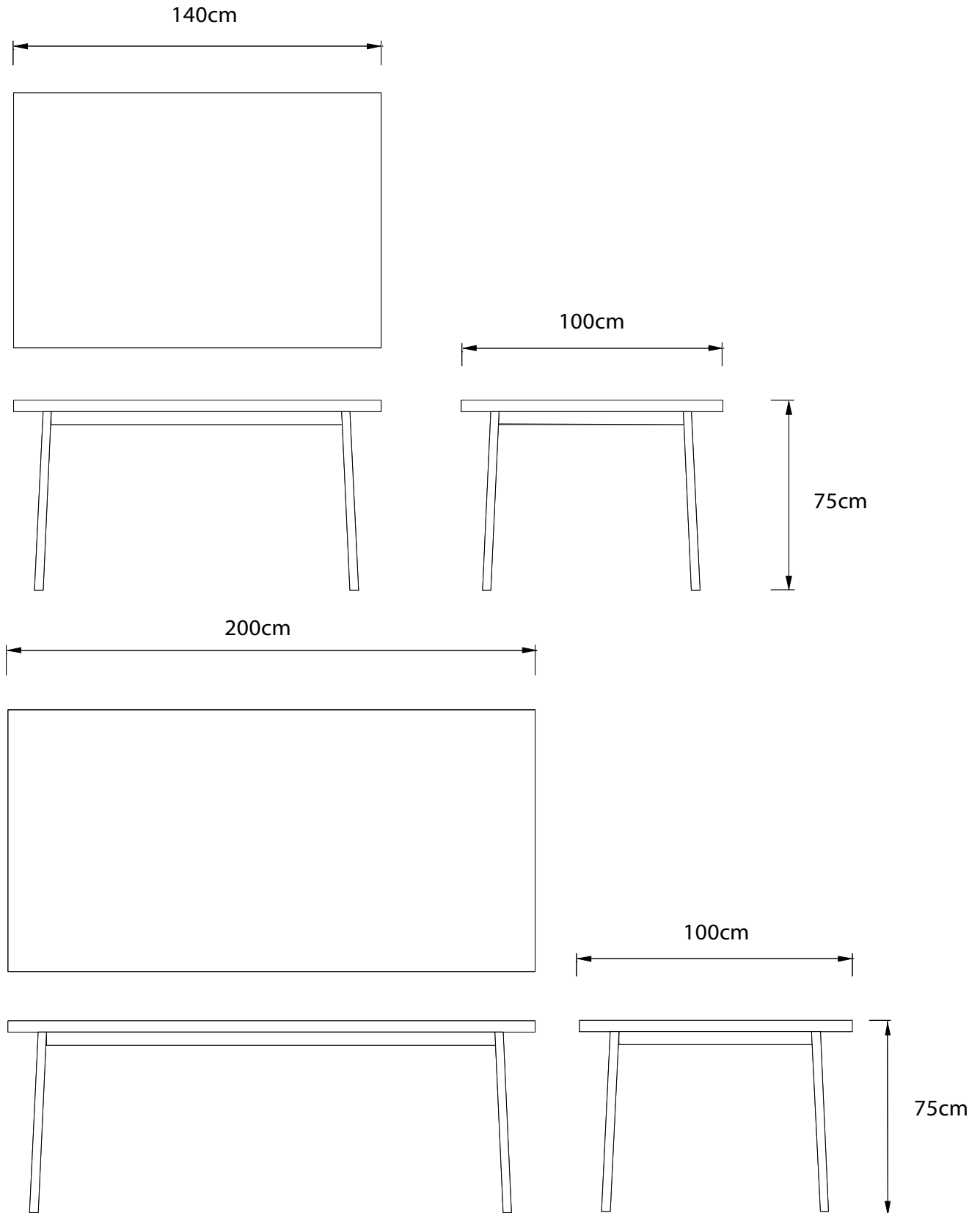



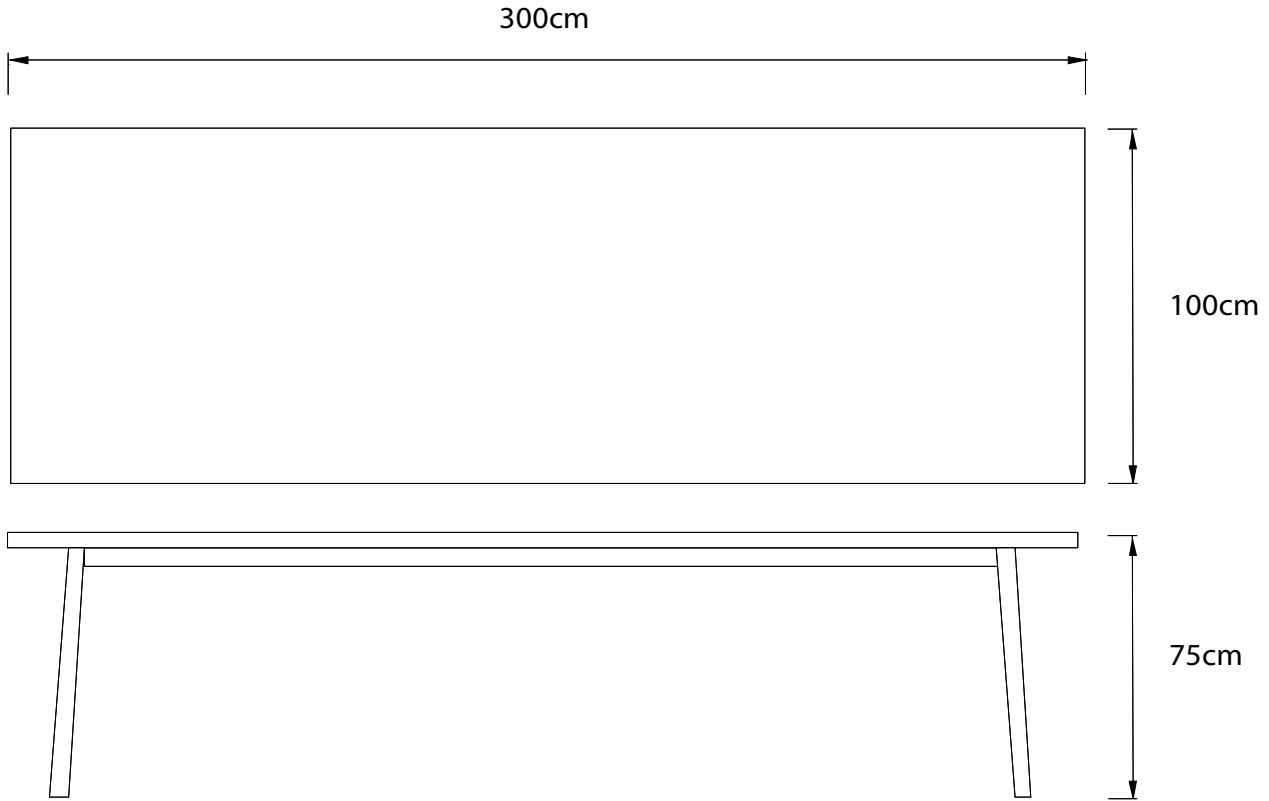





## Main dimensions



## Technical

The AVL table arrives with some assembly required before use. You will find the additional components inside the box. The additional components are the legs which need attaching to the table top and tightening down with the wing nuts that are supplied. These are tightened by simply turning them in a clockwise motion until they no longer turn.

## Packaging

	AVL-75 H-cm W-56cm D-51cm		AVL-140 H-95cm W-56cm D-51cm		AVL-200 H-95cm W-56cm D-51cm		AVL-300 H-95cm W-56cm D-51cm
	*-Colli **-Net 13.5-Gross		*-Colli **-Net 13.5-Gross		*-Colli **-Net 13.5-Gross		*-Colli **-Net 13.5-Gross

---

*Photography*



Rietmijer, The Netherlands

---

***Cleaning Instructions***

Moooi recommends using a good furniture polish and a soft cloth. Apply generously in layers to the surface and use the cloth to shine. Do not use abrasive fabrics, gently remove tough stains with warm water and a trusted multi-surface cleaner.

---